

SUBMERSIBLE RANGE

WSD



TRACER PUMPS

LEADING IN MOTION

24-01

WSD SUBMERSIBLE RANGE

Screened Sewage: 0.18 - 3.7kW

Applications

The WSD range is designed for:

- Sewage treatment plants
- Industrial draining
- Agriculture irrigation

Operating conditions

Liquid temperature: up to 40°C

Motor and Pump

Rewindable motor.

Single-phase: 220 - 240V/50Hz

Three-phase: 380 - 415V/50Hz



This range can also work in water containing fiber.

Motor and Pump

(according to our general sales conditions)

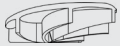

Components	Material
Motor external casing	AISI 304 SS
Mechanical seal	Graphite-Ceramic
Shaft	AISI 304 SS-ASTM 5140
Seal lubricant oil	Oil for food machinery and pharmaceutical use

Unshrouded impeller	Semi-open impeller
	
WSD8-7-0.18C	WSD15-10-0.37E
WSD9-8-0.25C	WSD20-12-0.55E
-	WSD20-15-0.75E
-	WSD25-15-1.1E
-	WSD28-18-1.5E
-	WSD35-22-2.2E
-	WS60-20-3E
-	WS65-25-3.7E

WS (D)8-7-0.18C(F)

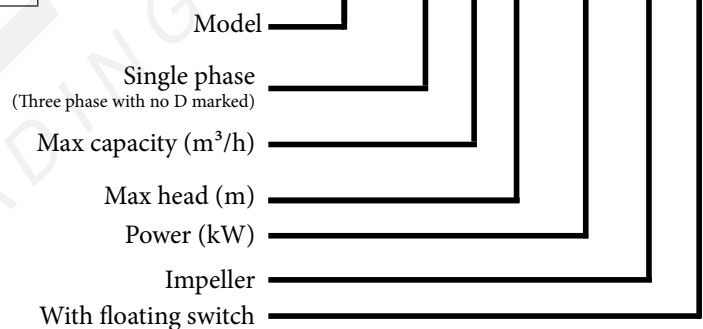

MODEL		POWER		DN	DIMENSIONS				WEIGHTS (KG)		THE MAX. FLOW PARTICLE
1~ 220 - 240V	3~ 380 - 415V	(kW)	(Hp)		W	L	H(S)	H(T)	G(S)	G(T)	(MM)
WSD8-7-0.18C	WS8-7-0.18C	0.18	0.25	1½"	65	170	400	390	12	11.5	15
WSD9-8-0.25C	WS9-8-0.25C	0.25	0.33	1½"	65	170	400	390	12.8	12.3	15
WSD20-12-0.55E	WS20-12-0.55E	0.55	0.75	2"	85	242	420	405	14.5	14	20
WSD20-15-0.75E	WS20-15-0.75E	0.75	1	2"	85	242	430	415	15.7	15.2	20
WSD25-15-1.1E	WS25-15-1.1E	1.1	1.5	2"	85	242	470	460	20	19	25
WSD28-18-1.5E	WS28-18-1.5E	1.5	2	2"	85	260	470	460	20	19	25
WSD35-22-2.2E	WS35-22-2.2E	2.2	3	2"	85	260	470	460	20	19	25
-	WS60-20-3E	3	4	3"	102	305	-	550	-	31	30
-	WS65-25-3.7E	3.7	5	3"	102	305	-	580	-	35.5	30

WSD SUBMERSIBLE RANGE

Performance Curve

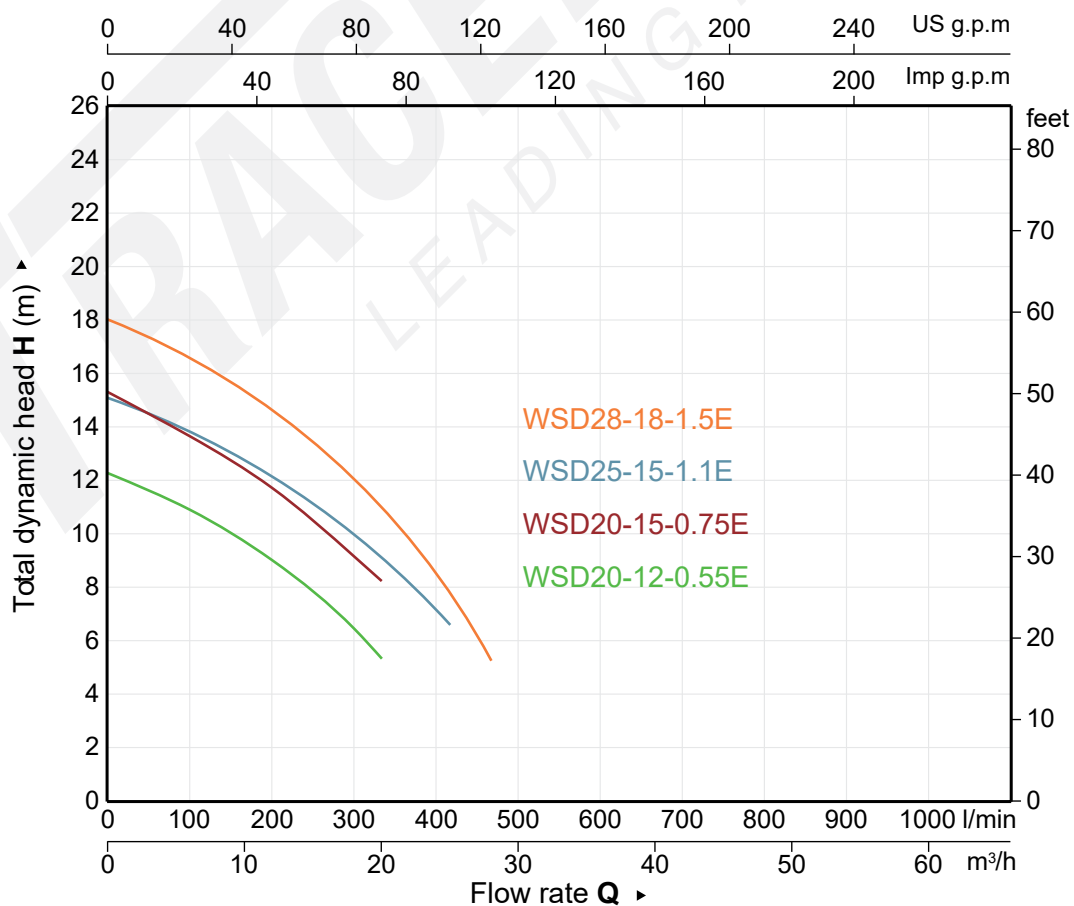
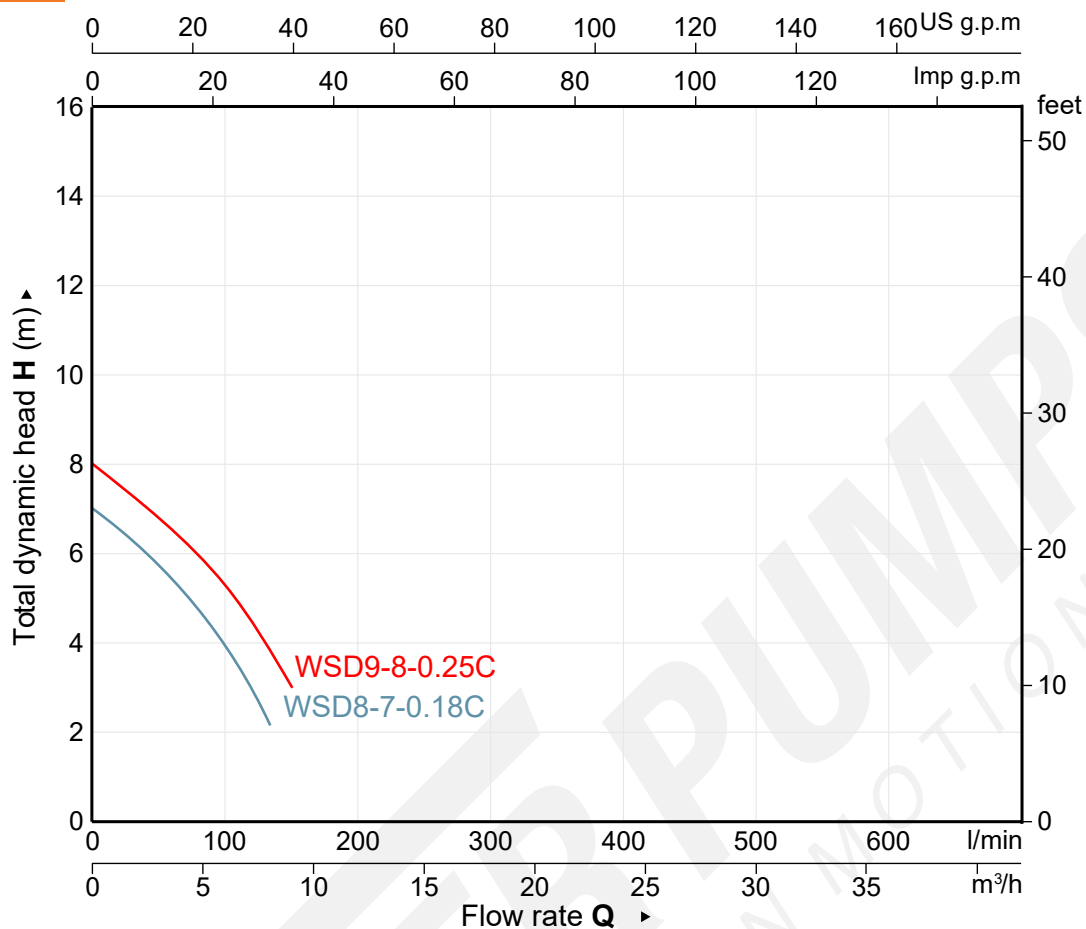

WSD SUBMERSIBLE RANGE

Performance Curve

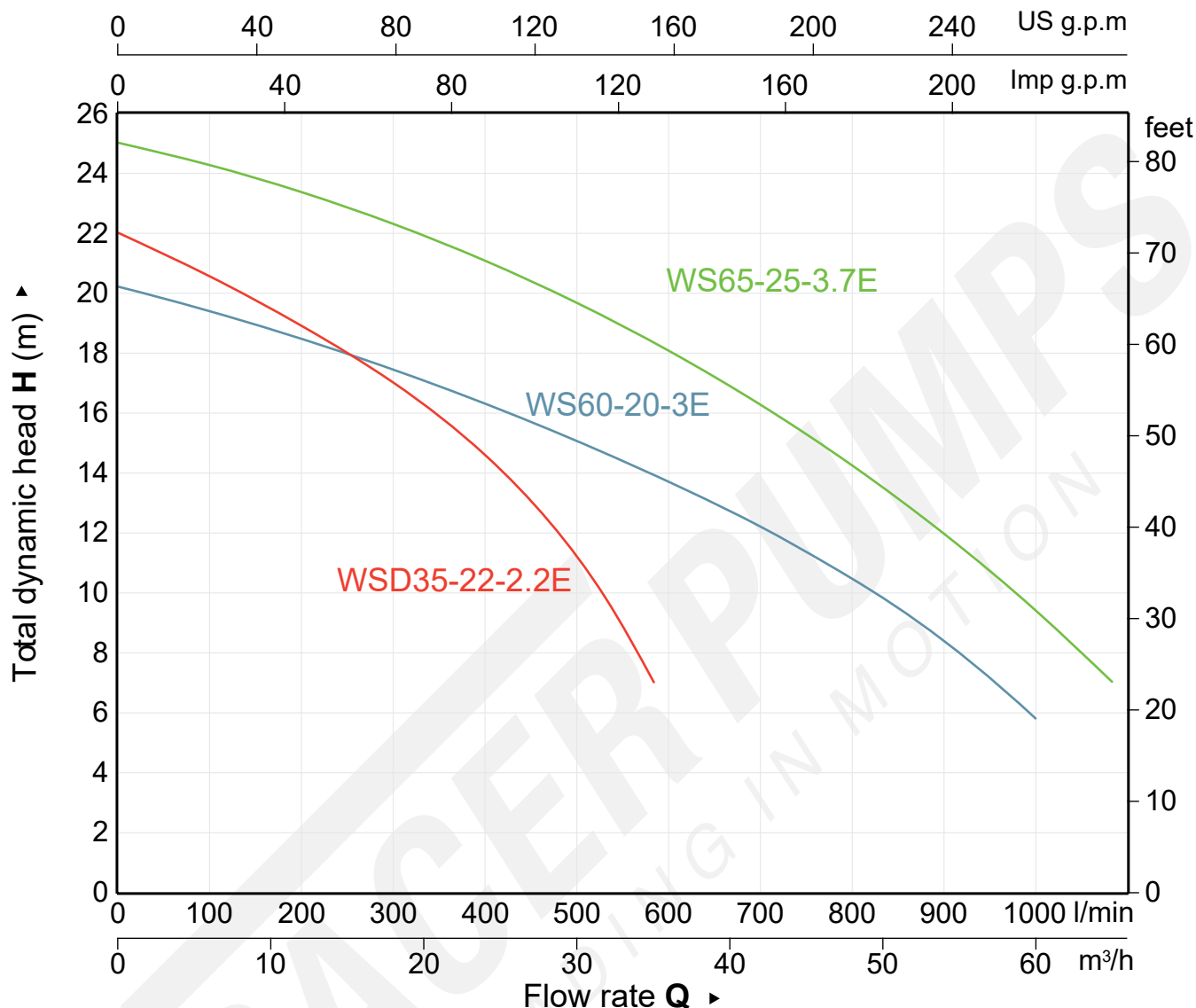

MODEL		P ₂		DELIVERY				
1~ 220 - 240V	3~ 380 - 415V	kW	HP	m³/h	0	3	6	9
				l/min	0	50	100	150
WSD8-7-0.18C	WS8-7-0.18C	0.18	0.25	HEAD (m)	7.1	6.0	3.8	
WSD9-8-0.25C	WS9-8-0.25C	0.25	0.33		8.0	7.0	5.0	3.0

MODEL		P ₂		DELIVERY															
1~ 220 - 240V	3~ 380 - 415V	kW	HP	m³/h	0	5	10	15	20	25	30	35	40	45	50	55	60	65	
				l/min	0	83	167	250	333	417	500	583	667	750	833	917	1000	1083	
WSD20-12-0.55E	WS20-12-0.55E	0.55	0.75	HEAD (M)	12.1	10.7	9.7	7.8	5.3										
WSD20-15-0.75E	WS20-15-0.75E	0.75	1		15.5	13.1	12.4	10.5	8.2										
WSD25-15-1.1E	WS25-15-1.1E	1.1	1.5		15.1	13.5	12.7	11.1	9.1	6.6									
WSD28-18-1.5E	WS28-18-1.5E	1.5	2		18.2	16.4	15.3	13.4	11	7.7									
WSD35-22-2.2E	WS35-22-2.2E	2.2	3		22.0	20.3	19.5	18	16.3	14	10.9	7.2							
-	WS60-20-3E	3	4		20.2	19.5	18.7	17.9	17	16.1	15	13.9	12.7	11.3	9.8	8	5.8		
-	WS65-25-3.7E	3.7	5		25.0	24.4	23.6	22.8	21.9	20.8	19.7	18.4	16.9	15.3	13.5	11.5	9.4	7	

WSD SUBMERSIBLE RANGE

EXPLODED VIEW

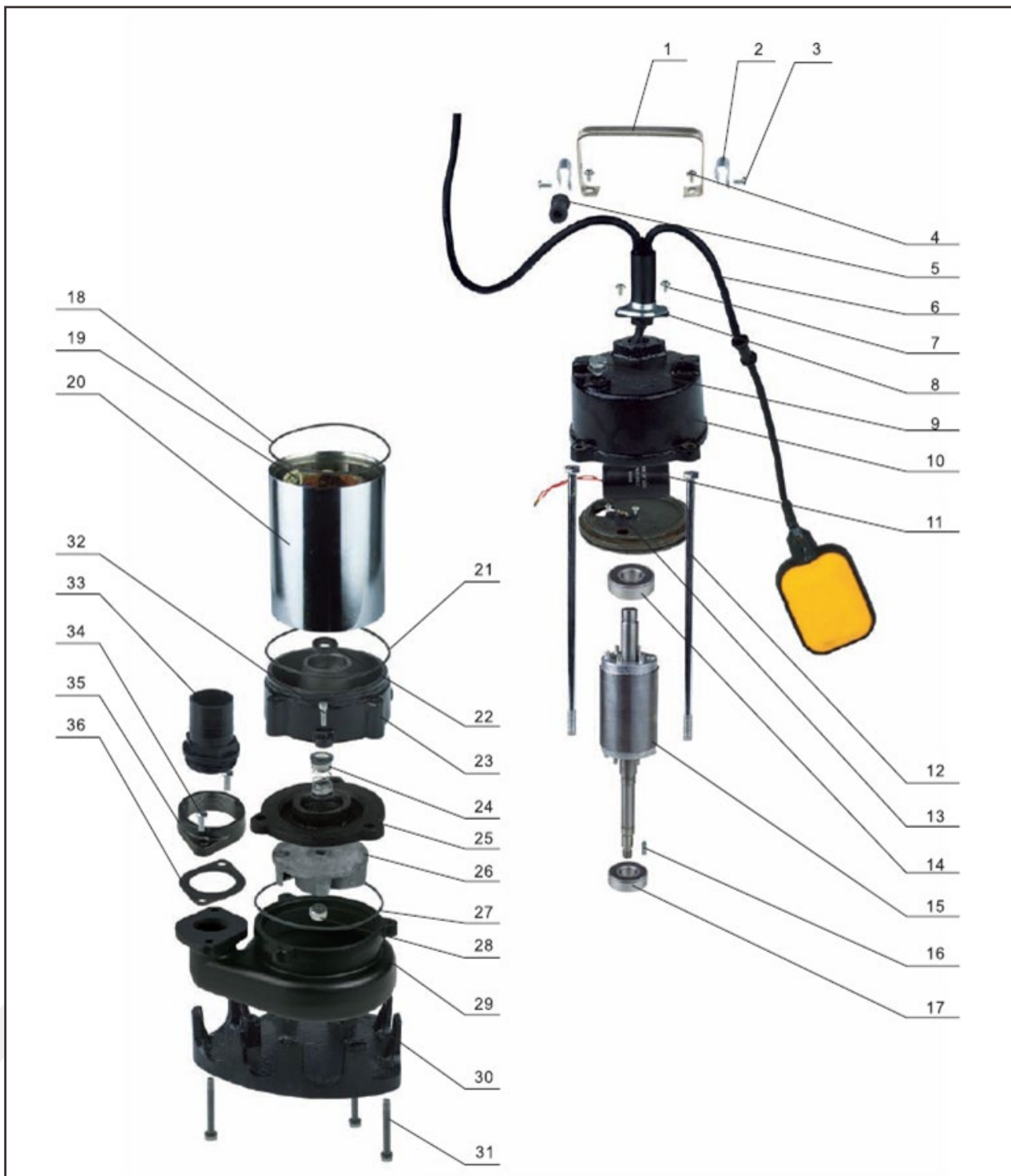

DIAGRAM									
No.	Description	No.	Description	No.	Description	No.	Description	No.	Description
1	Handle	9	Exhaust Plug	17	Bearing	25	Oil Tank Cover	33	Outlet Pipe
2	Fairlead	10	Top Cover	18	O-Ring	26	Impeller	34	Screw
3	Screw	11	Capacitor	19	Stator	27	O-Ring	35	Flange
4	Screw	12	Screw	20	Canister	28	Impeller Nut	36	Washer
5	Guard	13	Over-Load Protector	21	O-Ring	29	Pump Body		
6	Flow Switch	14	Bearing	22	Oil Seal	30	Pump Base		
7	Screw	15	Rotor	23	Oil Tank	31	Screw		
8	Seal Pressure Block	16	Key	24	Mechanical Seal	32	Screw		